

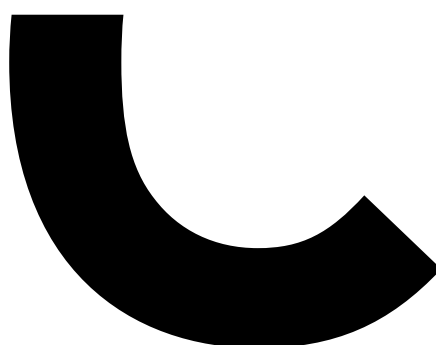

Marina



technical





Marina

Multifunctional desking and tables.
Contemporary styling, integrated ergonomics, discreet cable reticulation.
Co-ordinated compatibility with all Schiavello panel, storage and seating systems.

Index

desking **02-03**

cable reticulation **04**

accessories **05**

clusters **06-07**

meeting tables - rectilinear type M1 **08-09**

meeting tables - rectilinear type M2 **10**

meeting/utility tables - circular **11**

desking - return and table legs **12**

specification of marina desking and table system **13**



Desking

desks | returns

Key Features

Single span desk up to 2400 mm wide overall.
 Cast aluminium legs height adjustable from 675 mm to 750 mm with clear ABS foot pads. Finished polished or optional powdercoated white.
 Optional 80 mm locking castors.
 Optional clip in cable reticulation slats between beams.
 Selection of softwired desktop service modules.



LINEAR DESK

Optional modesty panel



code MAR/RD

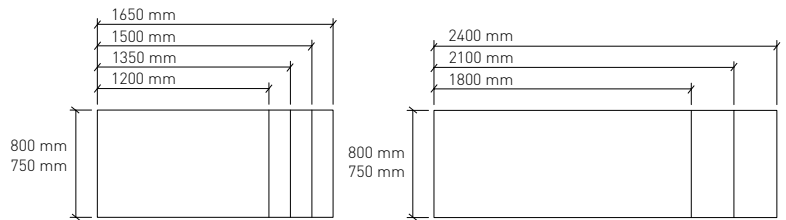
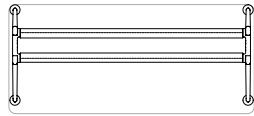

code MAR/RD-M

DESK RETURN - FREESTANDING



code MAR/FR

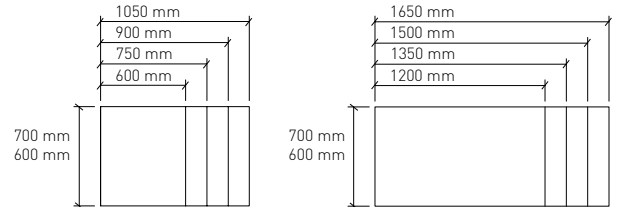
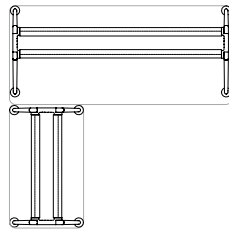

code MAR/FR-M



DESK RETURN - CONNECTED (non handed)

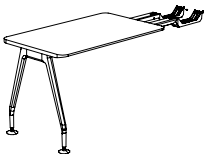

code MAR/CR

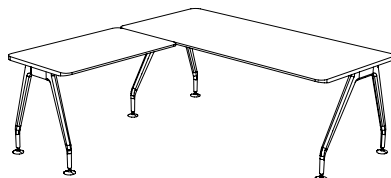
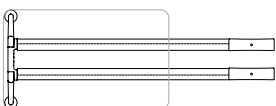
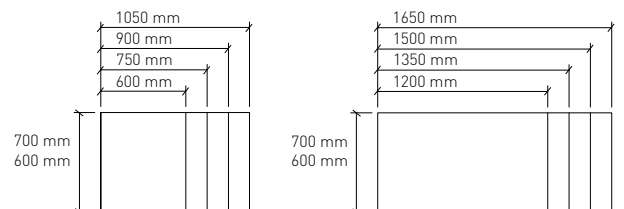
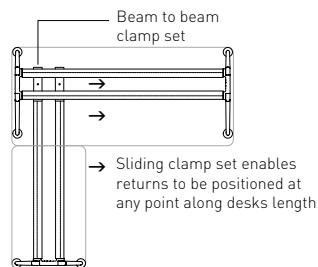

Extended return beams connect to desk beams eliminating end leg set

Desking

90° workstations | 120° workstations | worksurfaces

90° WORKSTATION

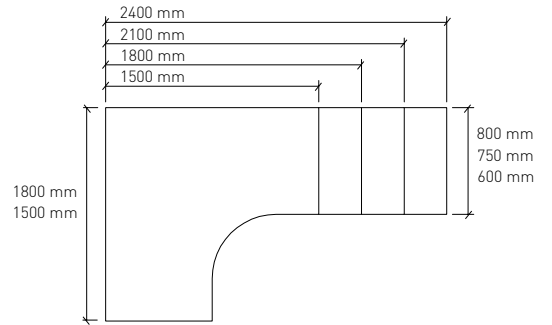
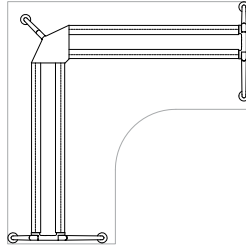
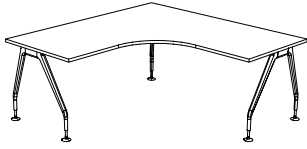

code MAR/90WS

120° WORKSTATION

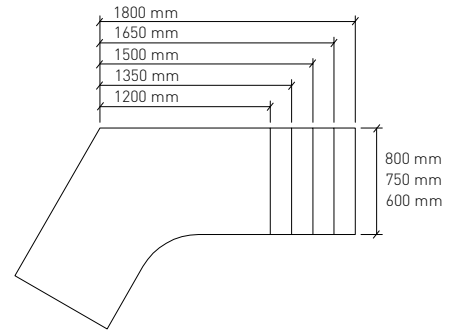
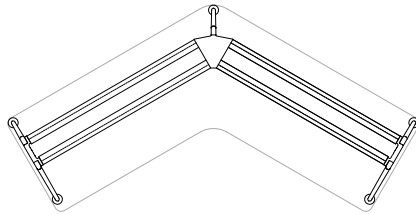
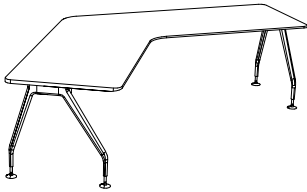

code MAR/120WS

WORKSURFACES

Standard worksurfaces can be specified either 25 mm or 33 mm thick with square or soft rounded corners (50 mm radius). Available finishes include laminates and timber veneers in selected colours. Edge profiles and finishes also offer choices with custom shapes available on request.

CORNER FINISH OPTIONS

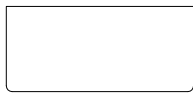
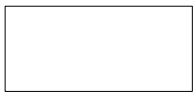

square corners

50 mm radius to front corners

50 mm radius to all corners

EDGE OPTIONS

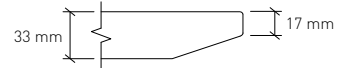
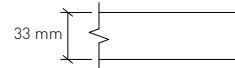
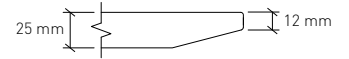
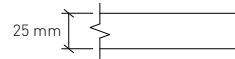

square

sharknose

HEIGHT ADJUSTMENT

Marina's height-adjustable legs have a total height adjustment range of 675 mm to 750 mm.

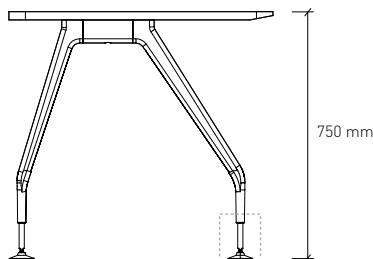
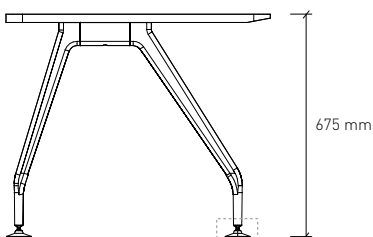

Marina desks and workstations have been designed to seamlessly integrate with each of the Schiavello panel systems, as well as the Interpower softwired cable reticulation system. By referring to the relevant product Technical Manual, complete product information can be obtained for each.

Cable reticulation

interpower softwiring system | desktop outlet modules | cable routing

Interpower softwiring system.

Schiavello interpower electrical softwiring system delivers power and lighting to office workstations. The system is easily connected, disconnected or relocated without the need to isolate power and with minimal inconvenience.

All connections within the Interpower system are protected by a positive lock mechanism to prevent accidental power disconnection. All components are factory tested and easy to install. All interpower softwiring components are reusable.

DESKTOP OUTLET OPTIONS

Service rail - mounts to rear of desktop
Available with either 2, 3 or 4 power outlets plus 2, 3 or 4 data voice/data points
Colour options - standard powdercoat range
Desktop thickness - to be specified when ordering

Service box - inserts into desktop
Available with either 2, 3 or 4 power outlets plus 2, 3 or 4 data voice/data points
Colour options - clear, black, white
Desktop thickness - to be specified when ordering

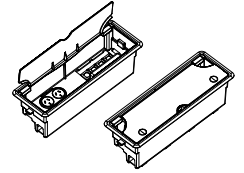

code SR/2P/4D
code SR/3P/4D
code SR/4P/4D
Mounts to rear of desktop

code IDB0.1
Power/Data service box

INTERPOWER SOFTWIRING SYSTEM

Refer to Schiavello Interpower brochure SCH/W05-C for complete product information and technical specifications



code SS
Starter sockets

code JB-S
Junction box

code EX-S00 (add length
i.e. 600 mm lead =
EX-S00600)
Extension leads

CABLE ROUTING

Optional duct slats that clip-in between the support beams form a large capacity duct through which cables are discreetly routed to the desktop outlet modules. (either service rail or service box). They can either terminate at the outlet module or re-enter the duct and continue on to the next required position.

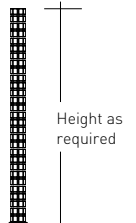
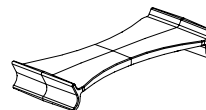
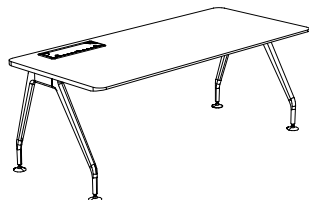
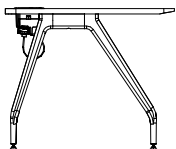
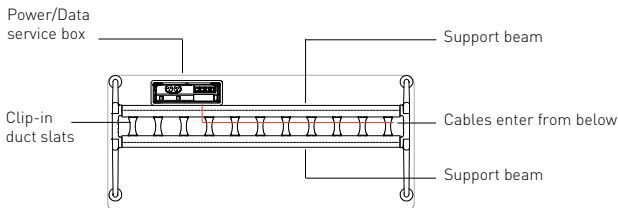

code MAR/CBL-RET
Service duct slats
Clip between support beams to form cable duct

code UMB
Umbilical
Carries cables to desk duct from either floor or ceiling

Accessories

mobile pedestals | CPU holder | desktop accessories

SYSTEMET MOBILE PEDESTALS

Construction - 0.95 mm zinc-seal, anti rust carcass and drawers.
 Powder coated finish available in selected colours.
 Drawers operate on runners with key locking system.
 Plastic injected moulded pencil drawer where shown. Timber drawer fronts optional.

Low height mobiles

Dimensions: 525 mm high x 450 mm wide x 500 mm deep

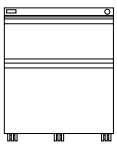

height 525 mm
 type S/MPL-2-500



height 525 mm
 type S/MPL-3-500

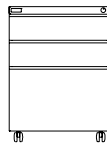

height 605 mm
 type S/MPT-3-500-600H



height 605 mm
 type S/MPT-2D/PD-500-600H

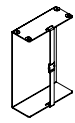

CPU holder

Dimensions: 450 mm high x 300 mm wide

type CPU-HLDR-QED
 Attaches to underside of desk top

DESKTOP ACCESSORIES

Accessory rail

Clamps to desktop
 Accepts all accessory trays
 Dimensions: 210 mm high x 800 mm wide

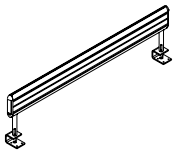

code QED-A/RAIL-800/25-ASSY-PC
 to suit 25 mm thick desk top

code QED-A/RAIL-800/33-ASSY-PC
 to suit 33 mm thick desk top

Accessory trays

Clip to accessory rail

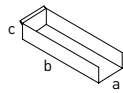

side_a 50 mm
 side_b 158 mm
 side_c 26 mm
 type ULT-PTRAY/SM
 Ultimet pencil tray - small

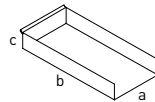

side_a 122 mm
 side_b 319 mm
 side_c 26 mm
 type ULT-PTRAY/LG
 Ultimet pencil tray - large

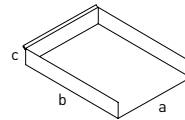

side_a 245 mm
 side_b 319 mm
 side_c 26 mm
 type ULT-STRAY
 Ultimet stationery tray - portrait

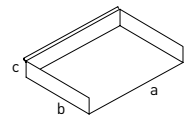

side_a 313 mm
 side_b 251 mm
 side_c 26 mm
 type ULT-STRAY-A4
 Ultimet paper tray - A4 landscape

MARINA LINEAR TYPE DESK

Fitted with IDB0.1 power data service box
 System 30 suspended panel attached with S30-CLM suspended panel attaching brackets

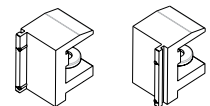

code S30/45-CLM-L.H.
 S30/45-CLM-R.H.
 Suspended panel attaching brackets

Clusters

Marina mobile linear desks and returns arranged alongside a System 45 post and panel freestanding wall. The wall provides services delivery and space division as well as allowing 'off module' placement and easy rearrangement of furniture. A System 30 suspended panel is attached by CLM clamp brackets to each of the mobile desks at the L.H. front of the cluster. QED tall boy storage units and a Marina MCT type circular meeting/utility table are also included.

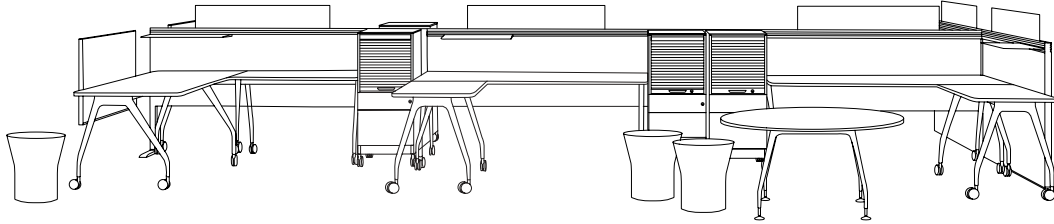

Marina 120° workstations arranged in a 3 way cluster with service delivery via a centre positioned freestanding Technology Column. A System 30 suspended panel divides each workstation and a QED low height 2 drawer mobile pedestal is provided for storage.

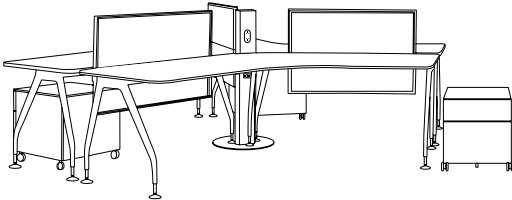

Marina 120° workstations arranged in a 3 way cluster with service delivery via a centre positioned Technology Column. System 45 floor standing panels are connected to each corner of the Technology Column creating a space division and stable freestanding panel cluster. QED tall boy storage units are included for high level storage capacity.

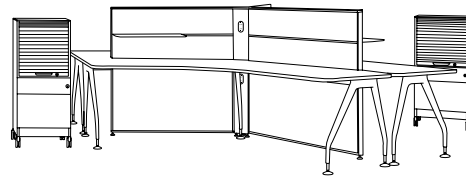

Marina linear desks each supported at one end by 2100 mm wide credenza storage units. A System 30 suspended panel divides the desks with two 2100 mm wide x 1100 mm high System 45 floor standing panels creating visual privacy.

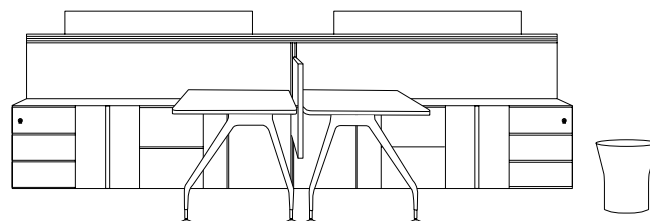

Clusters



Tables

meeting tables | rectilinear type M1

Marina rectilinear type M1 tables feature rigid cast aluminium and twin steel beam understructures that allow single span support for table tops up to 3000 mm wide and 1000 mm deep.

Height adjustable legs enable table height adjustment to ensure maximum comfort compatibility with all types of seating.

Optional cable reticulation via Umbilical to concealed metal tray with table top access.

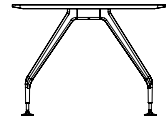
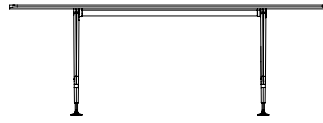

1800 mm wide x 900/1000 mm deep

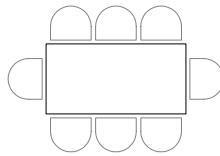
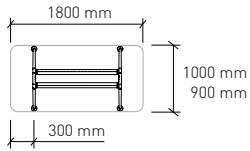
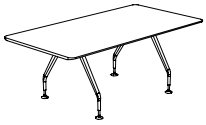

code ME1 18.9 (900 mm deep)
ME1 18.10 (1000 mm deep)

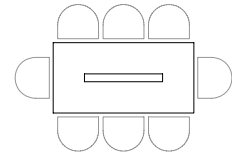

code ME1 18.9S (900 mm deep)
ME1 18.10S (1000 mm deep)

2000 mm wide x 900/1000 mm deep

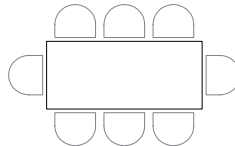
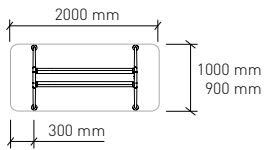

code ME1 20.9 (900 mm deep)
ME1 20.10 (1000 mm deep)

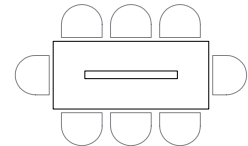

code ME1 20.9S (900 mm deep)
ME1 20.10S (1000 mm deep)

2400 mm wide x 900/1000 mm deep

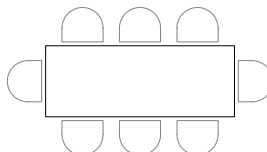
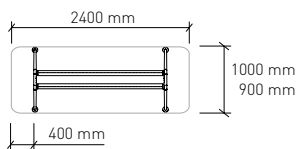
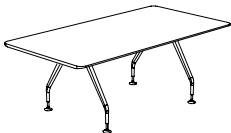

code ME1 24.9 (900 mm deep)
ME1 24.10 (1000 mm deep)

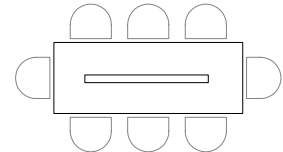

code ME1 24.9S (900 mm deep)
ME1 24.10S (1000 mm deep)

Tables

meeting tables | rectilinear type M1

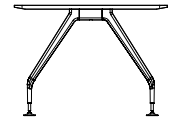
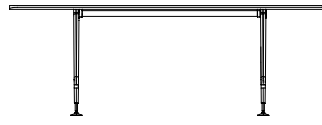

2700 mm wide x 900/1000 mm deep

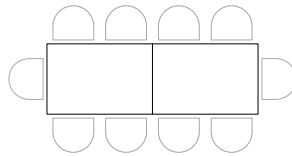
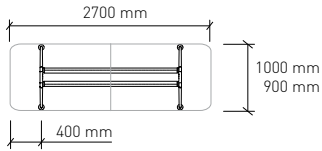
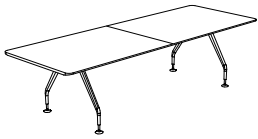

code ME1 27.9 (900 mm deep)
ME1 27.10 (1000 mm deep)

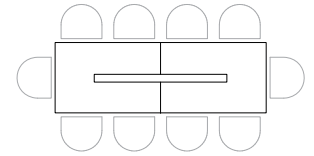

code ME1 27.9S (900 mm deep)
ME1 27.10S (1000 mm deep)

3000 mm wide x 900/1000 mm deep

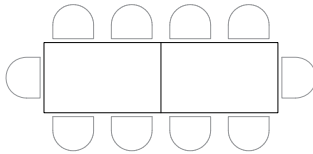
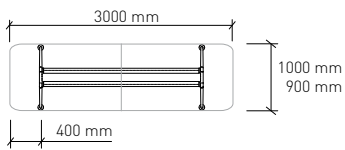
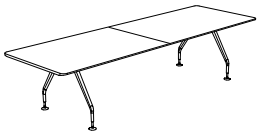

code ME1 30.9 (900 mm deep)
ME1 30.10 (1000 mm deep)

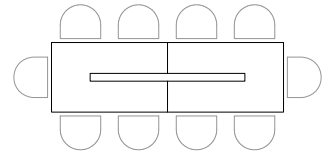

code ME1 30.9S (900 mm deep)
ME1 30.10S (1000 mm deep)

TABLE TOP OPTIONS FOR TYPE M1 AND M2 RECTILINEAR TABLES

Standard table tops are 33 mm thick with square or soft rounded corners. (50 mm radius). Available finishes include laminates and timber veneers in selected colours. Edge profiles and finishes also offer choices with custom shapes available upon request.

CORNER FINISH OPTIONS



square corners



50 mm radius corners

EDGE OPTIONS

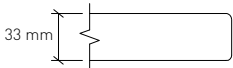

square

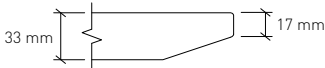

sharknose

CABLE RETICULATION TRAYS IN-BUILT WITH TABLETOP ACCESS

Type M1 Rectilinear Tables ONLY

Single hinged flap entry to concealed metal cable tray. Extensive range of clip-in services outlet modules to suit requirements

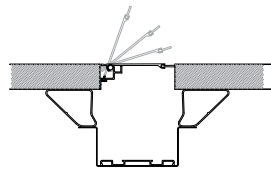

Umbilical Cable Entry

Cables enter cable tray from beneath via Umbilical

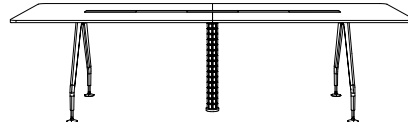

Type M2 Rectilinear Tables ONLY

Double hinged flap entry to concealed metal cable tray. Extensive range of clip-in services outlet modules to suit requirements

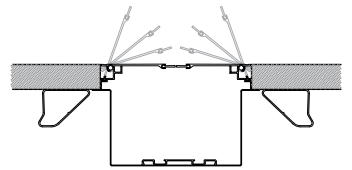

Tables

meeting tables | rectilinear type M2

Marina type M2 tables feature a unique rigid cast aluminium and steel beam understructure with two sets of support beams allowing single spans for tables up to 3600 mm long and 1500 mm wide. Height adjustable legs enable table height adjustment to ensure maximum comfort compatibility with all types of seating. Optional cable reticulation via Umbilical to concealed metal tray with table top access.

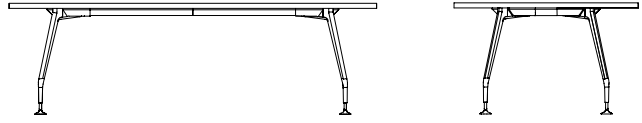

2400 mm wide x 1200/1500 mm deep

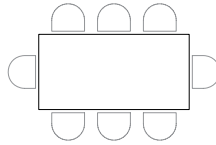
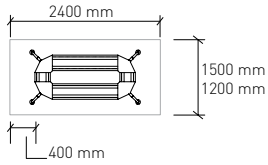
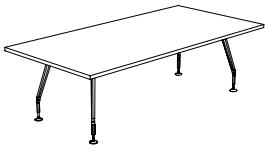

code ME2 24.12 (1200 mm deep)
ME2 24.15 (1500 mm deep)

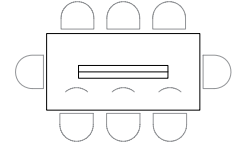

code ME2 24.12S (1200 mm deep)
ME2 24.15S (1500 mm deep)

3000 mm wide x 1200/1500 mm deep

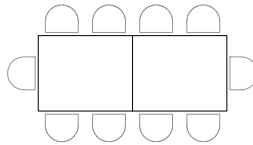
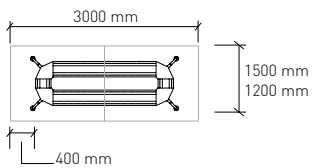
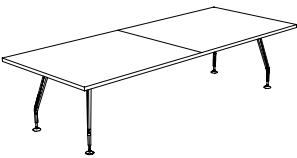

code ME2 30.12 (1200 mm deep)
ME2 30.15 (1500 mm deep)

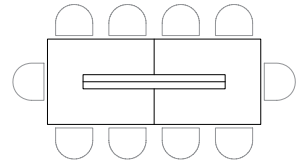

code ME2 30.12S (1200 mm deep)
ME2 30.15S (1500 mm deep)

3600 mm wide x 1200/1500 mm deep

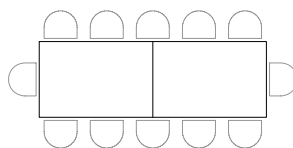
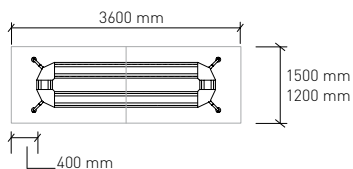
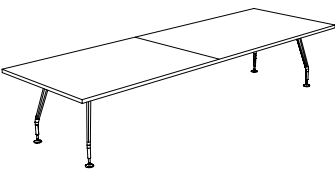

code ME2 36.12 (1200 mm deep)
ME2 36.15 (1500 mm deep)

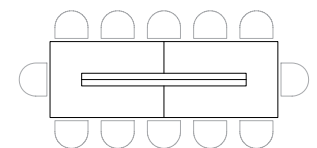

code ME2 36.12S (1200 mm deep)
ME2 36.15S (1500 mm deep)

Tables

meeting | utility tables - circular

Marina's circular tables feature cast aluminium height adjustable legs that enable table height adjustment from 675 mm to 750 mm. This ensures maximum comfort compatibility with all types of seating. Legs are connected to a unique press formed steel under carriage that achieves table rigidity and stability. Optional legs fitted with 80 mm locking castors for mobile tables up to 1200 mm diam. are also available.

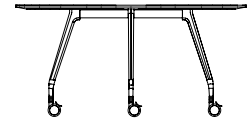
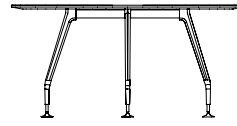

900 mm diameter

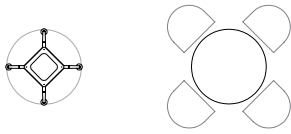
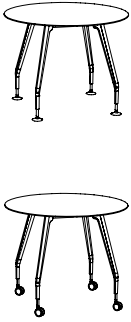

code MCT 900 (height adjustable legs)
MCT 900M (mobile with castors)

1500 mm diameter

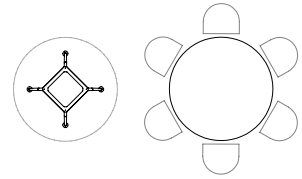

code MCT 1500 (height adjustable legs)

1050 mm diameter

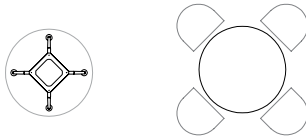
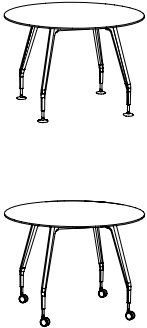

code MCT 1050 (height adjustable legs)
MCT 1050M (mobile with castors)

1800 mm diameter

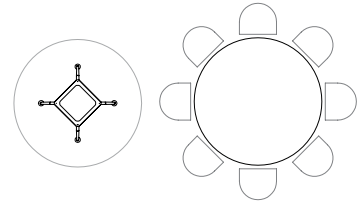
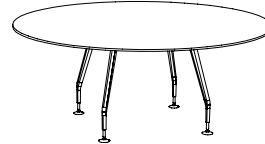

code MCT 1800 (height adjustable legs)

1200 mm diameter

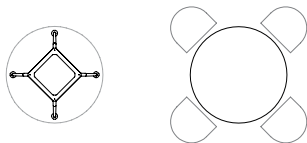
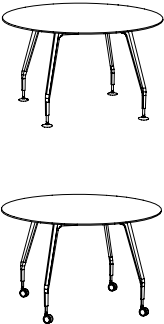

code MCT 1200 (height adjustable legs)
MCT 1200M (mobile with castors)

TABLE TOP OPTIONS FOR CIRCULAR TABLES

Circular table tops can be specified either 25 mm or 33 mm thick. Available finishes include laminates and timber veneers in selected colours. Edge profiles and finishes also offer choices with custom shapes available on request.

EDGE OPTIONS

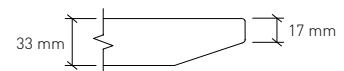
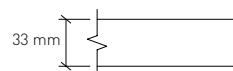
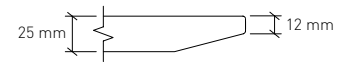
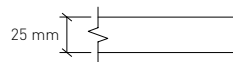

square

sharknose

Marina desking, return and table legs

height adjustable | mobile | cantilever support

Marina desking, return and table legs are available as either -
a - Height adjustable with adjustment range of 675 mm to 750 mm.
b - Mobile type, fitted with 80 mm locking castors. 725 mm high.

DESK LEGS

For desk tops 750/800 mm deep

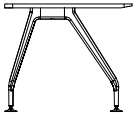

code MLBF
height adjustable

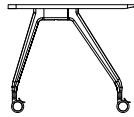

code MLBFC
mobile

DESK RETURN LEGS

For desk tops 600/700 mm deep

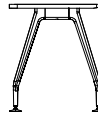

code MLBB
height adjustable



code MLBBC
mobile

TABLE LEGS

For M1 type linear tables 900/1000 mm deep

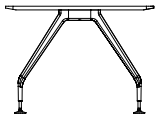

code MLFF
height adjustable

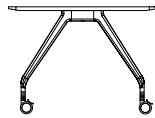

code MLFFC
mobile

TABLE LEGS

For M2 type linear tables 1200/1500 mm deep



code ML4B-BR
height adjustable

TABLE LEGS

For circular tables

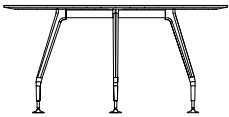

code ML4B-CR
height adjustable

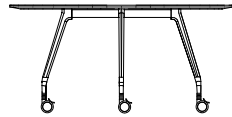

code ML4BC-CR
mobile

CANTILEVER LEGS

Height adjustable
Support legs for panel mounted worktops

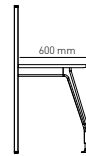

code MLB-BKT

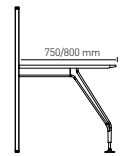

code MLF-BKT



Product specifications

height adjustable | cable reticulation | divisional screens | finish
| worktops | sustainable | warranty

Marina is a fully refined office desking and table system manufactured in Australia by Schiavello.

The system is modular, beam based with a broad range of applications.

These include:

- Ergonomic rectilinear office desking and workstations available in both conventional and bridged clusters
- Executive desking
- Conference and boardroom tables

All items are available as either fixed height or height adjustable.

Tested for strength, durability, stability, function and ergonomics conforming to:

Australian Standard AS/NZ 4442: 1997 "Office Desks", and International Standard ISO 21016 "Office Furniture – Tables and Desks".

Height adjustable

Marina is available in a number of height adjustable options that can be infinitely varied within the particular adjustment range. These options are:

- Technician adjustable – easy individual leg adjustment
- Standard height adjustment range: 675 mm to 750 mm

Cable reticulation

The system includes optional clip-on segregated cable reticulation trays and a selection of services outlet modules and soft wiring connections. Also included are integrated components that provide efficient means of routing services cabling to the cable trays from the ceiling, walls or floor, for example, power blades, umbilicals and power poles.

The softwiring electrical system is Schiavello Interpower, certified to Australian Standard AS/NZS 3131.

Divisional screens

Marina is compatible with Schiavello System 30 and System 45 divisional screens and includes a complete range of panel attaching brackets suitable for both floor standing and desk suspended panels.

Finish

All aluminium is powder coated to Australian Standard AS 3715-2002 in a range of standard or custom colours.

All metal components are powder coated to Australian Standard AS4506 2005 in a range of standard or custom colours.

Worktops

Standard worktops can be specified 25 mm or 33 mm thick with square or soft rounded corners (50 mm radius). Available finishes include selected laminates, timber veneers and powder coated MDF in a range of standard or custom colours. Custom edge profiles and finishes are also available upon request, offering vast design possibilities.

Sustainable

Marina is manufactured in accordance with international environmental standards: ISO 14001. All components are either reusable or recyclable. In certain configurations, Marina can meet the 7-out-of-7 Green Star MAT Calculator points for 6 Green Star rated interiors.

Warranty

Marina is covered by a five year warranty against faulty materials and workmanship. This includes a guarantee to all standard parts, components and service for a period of no less than 10 years from date of installation.



